



**Economic and Social
Council**

Distr.
GENERAL

ECE/TRANS/ SC.1/2006/2
9 August 2006

ENGLISH
Original: ENGLISH AND FRENCH

ECONOMIC COMMISSION FOR EUROPE

INLAND TRANSPORT COMMITTEE

Working Party on Road Transport
One hundredth session
Geneva, 17-19 October 2006
Item 4 of the provisional agenda

HARMONIZATION OF REQUIREMENTS CONCERNING INTERNATIONAL ROAD
TRANSPORT AND FACILITATION OF ITS OPERATION

Consolidated text of the European Agreement Concerning the Work of Crews of Vehicles
Engaged in International Road Transport (AETR)

INTRODUCTION

In order to facilitate the understanding and reading of the European Agreement Concerning the Work of Crews of Vehicles Engaged in International Road Transport (AETR), done on 1 July 1970, the secretariat has prepared a consolidated version of the Agreement in which the relevant amendments adopted since its origin have been incorporated. **No legal value should be attached to this consolidated version.**

The consolidated text comprises the original Agreement (E/ECE/811; E/ECE/TRANS/564), amendments 1-4 (E/ECE/811; E/ECE/TRANS/564/Amend. 1-4 which entered into force respectively on 3 August 1983, 24 April 1992, 28 February 1995 and 27 February 2004) as well as the fifth and latest amendment, which entered into force on 16 June 2006 and is published under the symbol TRANS/SC.1/375/Add.1. This consolidated version is preceded by a non-official table of contents prepared by the secretariat to facilitate searches in the document.

CONTENT

| | | page |
|---|---|------|
| Body of the AETR | | 7 |
| Article 1 | Definitions | 7 |
| Article 2 | Scope | 9 |
| Article 3 | Application of some provisions of the Agreement to road transport performed by vehicles registered in the territories of non-Contracting States | 10 |
| Article 4 | General principles | 10 |
| Article 5 | Crews | 10 |
| Article 6 | Driving periods | 11 |
| Article 7 | Breaks | 12 |
| Article 8 | Rest periods | 12 |
| Article 9 | Exceptions | 13 |
| Article 10 | Control device | 13 |
| Article 11 | Supervision by the undertaking | 14 |
| Article 12 | Measures of enforcement of the Agreement | 14 |
| Article 13 | Transitional provisions | 16 |
| Article 14 | Final provisions | 17 |
| Article 15 | (Denunciation of the Agreement) * | 17 |
| Article 16 | (Termination) | 17 |
| Article 17 | (Declaration concerning the application to territories) | 17 |
| Article 18 | (Dispute) | 18 |
| Article 19 | (Reservations) | 18 |
| Article 20 | (Convocation of a diplomatic conference) | 19 |
| Article 21 | (Amendment of the Agreement and the Annex) | 19 |
| Article 22 | (Amendment of Appendixes 1 and 2) | 21 |
| Article 22 bis | Procedure for the amendment of Appendix 1B | 21 |
| Article 23 | (Notification to States) | 22 |
| Article 24 | (Protocol of signature) | 23 |
| Article 25 | (Depositary) | 23 |
| Annex to the Agreement Control device | | 24 |
| Chapter 1 | Type approval (articles 1 to 8) | 24 |
| Chapter 2 | Installation and inspection (article 9) | 26 |

* Titles between brackets do not have an official character.

| | | |
|------------------------------|---|----|
| Chapter 3 | Use of equipment (articles 10 to 14) | 27 |
| Appendix 1 | Requirements for construction, testing, installation and inspection | 34 |
| Chapter 1 | Definitions | 34 |
| Chapter II | General characteristics and functions of control device | 34 |
| Chapter III | Construction requirements for control device | |
| | 35 | |
| | A. General points | 35 |
| | B. Visual instruments | 37 |
| | C. Recording instruments | 38 |
| | D. Closing device | 40 |
| | E. Markings | 40 |
| | F. Maximum tolerances (visual and recording instruments) | 41 |
| Chapter IV | Record sheets | 42 |
| | A. General points | 42 |
| | B. Recording areas and their graduation | 43 |
| | C. Information to be printed on the record sheets | 43 |
| | D. Free space for handwritten insertions | 43 |
| Chapter V | Installation of control device | 44 |
| | A. General points | 44 |
| | B. Sealing | 44 |
| | 44 | |
| Chapter VI | Checks and inspections | 45 |
| Appendix 1B | Requirements for the construction, testing, installation and inspection of the digital control device used in road transport | 47 |
| Article 1 | Preamble | 47 |
| Article 2 | Introductory provisions to Appendix 1B | 47 |
| Appendix 2 | Approval marks and certificates | 50 |
| | I. Approval mark | 50 |
| | II. Approval certificate for products in accordance with Appendix 1 | 52 |
| | III. Approval certificate for products in accordance with Appendix 1B | 53 |
| Protocol of signature | | 56 |

NATIONS UNIES



UNITED NATIONS

**ECONOMIC COMMISSION FOR EUROPE
INLAND TRANSPORT COMMITTEE**

**EUROPEAN AGREEMENT CONCERNING THE WORK OF CREWS OF VEHICLES
ENGAGED IN INTERNATIONAL ROAD TRANSPORT
(AETR)**

AND PROTOCOL OF SIGNATURE
done at Geneva on 1 July 1970

EUROPEAN AGREEMENT CONCERNING THE WORK OF CREWS OF VEHICLES ENGAGED IN INTERNATIONAL ROAD TRANSPORT (AETR)

The Contracting Parties,

Being desirous of promoting the development and improvement of the international transport of passengers and goods by road,

Convinced of the need to increase the safety of road traffic, to make regulations governing certain conditions of employment in international road transport in accordance with the principles of the International Labour Organisation, and jointly to adopt certain measures to ensure the observance of those regulations,

Have agreed as follows:

Article 1

Definitions

For the purposes of this Agreement:

- (a) “vehicle” means any motor vehicle or trailer; this term includes any combination of vehicles;
- (b) “motor vehicle” means any self-propelled road vehicle which is normally used for carrying persons or goods by road or for drawing, on the road, vehicles used for the carriage of persons or goods; this term does not include agricultural tractors;
- (c) “trailer” means any vehicle designed to be drawn by a motor vehicle and includes semi-trailers;
- (d) “semi-trailer” means any trailer designed to be coupled to a motor vehicle in such a way that part of it rests on the motor vehicle and that a substantial part of its weight and of the weight of its load is borne by the motor vehicle;
- (e) “combination of vehicles” means coupled vehicles which travel on the road as a unit;
- (f) “permissible maximum weight” means the maximum weight of the laden vehicle declared permissible by the competent authority of the State in which the vehicle is registered;
- (g) “carriage by road”¹ means any journey made on roads open to the public of a vehicle, whether laden or not, used for the carriage of passengers or goods;
- (h) “international road transport” [“international carriage by road”] means road transport which involves the crossing of at least one frontier;

¹ Definition introduced by amendment 2.

(i) “regular services”² means services which provide for the carriage of passengers at specified intervals along specified routes, passengers being taken up and set down at predetermined stopping points.

Rules governing the operations of services or documents taking the place thereof, approved by the competent authorities of Contracting Parties and published by the carrier before coming into operation, shall specify the conditions of carriage and in particular the frequency of services, timetables, faretables and the obligation to accept passengers for carriage, insofar as such conditions are not prescribed by any law or regulation.

Services by whomsoever organized, which provide for the carriage of specified categories of passengers to the exclusion of other passengers, insofar as such services are operated under the conditions specified in the first subparagraph of this definition, shall be deemed to be regular services. Such services, in particular those providing for the carriage of workers to and from their place of work or of schoolchildren to and from school, are hereinafter called “special regular services”;

(j) “driver” means any person, whether wage-earning or not, who drives the vehicle even for a short period, or who is carried on the vehicle in order to be available for driving if necessary;

(k) “crew member” means the driver or either of the following, whether wage-earning or not:

- (i) a driver's mate, i.e. any person accompanying the driver in order to assist him in certain manoeuvres and habitually taking an effective part in the transport operations, though not a driver in the sense of paragraph (j) of this article;
- (ii) a conductor, i.e. any person who accompanies the driver of a vehicle engaged in the carriage of passengers and is responsible in particular for the issue or checking of tickets or other documents entitling passengers to travel on the vehicle;

(l) “week”³ means the period between 0000 hours on Monday and 2400 hours on Sunday;

(m) “rest”⁴ means any uninterrupted period of at least one hour during which the driver may freely dispose of his time.

2 Definition introduced by amendment 2.

3 Definition introduced by amendment 2.

4 Definition introduced by amendment 2.

Article 2

Scope

1. This Agreement shall apply in the territory of each Contracting Party to all international road transport performed by any vehicle registered in the territory of the said Contracting Party or in the territory of any other Contracting Party.

2. Nevertheless,

(a) if, in the course of an international road transport operation one or more crew members do not leave the national territory in which they normally exercise their occupational activities, the Contracting Party for that territory shall be free not to apply to him or them the provisions of this Agreement;

(b) Unless the Contracting Parties whose territory is used agree otherwise, this Agreement shall not apply to the international road transport performed by:⁵

1. Vehicles used for the carriage of goods where the permissible maximum weight of the vehicle, including any trailer or semi-trailer, does not exceed 3.5 tonnes;
2. Vehicles used for the carriage of passengers which, by virtue of their construction and equipment are suitable for carrying not more than nine persons, including the driver, and are intended for that purpose;
3. Vehicles used for the carriage of passengers on regular services where the route covered by the service in question does not exceed 50 kilometres;
4. Vehicles with a maximum authorized speed not exceeding 30 kilometres per hour;
5. Vehicles used by or under the control of the armed services, civil defence, fire services, and forces responsible for maintaining public order;
6. Vehicles used in connection with the sewerage, flood protection, water, gas and electricity services, highway maintenance and control, refuse collection and disposal, telegraph and telephone services, carriage of postal articles, radio and television broadcasting and the detection of radio or television transmitters or receivers;
7. Vehicles used in emergencies or rescue operations;
8. Specialized vehicles used for medical purposes;
9. Vehicles transporting circus and funfair equipment;
10. Specialized breakdown vehicles;

⁵ Modified by amendment 2.

11. Vehicles undergoing road tests for technical development, repair or maintenance purposes, and new or rebuilt vehicles which have not yet been put into service;
12. Vehicles used for non-commercial carriage of goods for personal use;
13. Vehicles used for milk collection from farms and the return to farms of milk containers or milk products intended for animal feed.

Article 3⁶

Application of some provisions of the Agreement to road transport performed by vehicles registered in the territories of non-Contracting States

1. Each Contracting Party shall apply in its territory, in respect of international road transport performed by any vehicle registered in the territory of a State which is not a Contracting Party to this Agreement, provisions not less strict than those laid down in articles 5, 6, 7, 8, 9 and 10 of this Agreement.
2. It shall be open to any Contracting Party, in the case of a vehicle registered in a State which is not a Contracting Party to this Agreement, merely to require, in lieu of a control device conforming to the specifications in the annex to this Agreement, daily record sheets, completed manually by the driver.

Article 4⁷

General principles

Each Contracting Party may apply higher minima or lower maxima than those laid down in articles 5 to 8 inclusive. Nevertheless, the provisions of this Agreement shall remain applicable to drivers, engaged in international road transport operations on vehicles registered in another Contracting or non-Contracting State.

Article 5⁸

Crews

1. The minimum ages for drivers engaged in the carriage of goods shall be as follows:
 - (a) for vehicles, including, where appropriate, trailers or semi-trailers, having a permissible maximum weight of not more than 7.5 tonnes, 18 years;
 - (b) for other vehicles:

21 years, or 18 years provided that the person concerned holds a certificate of professional competence recognized by one of the Contracting Parties confirming that he has completed a

6 Modified by amendment 1 and amendment 2.

7 Modified by amendment 2.

8 Modified by amendment 2.

training course for drivers of vehicles intended for the carriage of goods by road. Contracting Parties shall inform one another of the prevailing national minimum training levels and other relevant conditions relating to drivers engaged in international carriage of goods under this Agreement.

2. Any driver engaged in the carriage of passengers shall have reached the age of 21 years.

Any driver engaged in the carriage of passengers on journeys beyond a 50 kilometre radius from the place where the vehicle is normally based must also fulfil one of the following conditions:

(a) he must have worked for at least one year in the carriage of goods as a driver of vehicles with a permissible maximum weight exceeding 3.5 tonnes;

(b) he must have worked for at least one year as a driver of vehicles used to provide passenger services on journeys within a 50 kilometre radius from the place where the vehicle is normally based, or other types of passenger services not subject to this Agreement provided the competent authority considers that he has by so doing acquired the necessary experience;

(c) he must hold a certificate of professional competence recognized by one of the Contracting Parties confirming that he has completed a training course for drivers of vehicles intended for the carriage of passengers by road.

Article 6⁹

Driving periods

1. The driving period between any two daily rest periods or between a daily rest period and a weekly rest period, hereinafter called “daily driving period”, shall not exceed nine hours. It may be extended twice in any one week to ten hours.

A driver must, after no more than six daily driving periods, take a weekly rest period as defined in article 8 (3).

The weekly rest period may be postponed until the end of the sixth day if the total driving time over the six days does not exceed the maximum corresponding to six daily driving periods.

In the case of the international carriage of passengers, other than on regular services, the terms “six”, and “sixth”, in the second and third subparagraphs shall be replaced by “twelve”, and “twelfth”, respectively.

2. The total period of driving in any one fortnight shall not exceed ninety hours.

Article 7¹⁰

Breaks

9 Modified by amendment 2.

10 Modified by amendment 2.

1. After four-and-a-half hours' driving, the driver shall observe a break of at least forty-five minutes, unless he begins a rest period.
2. This break may be replaced by breaks of at least fifteen minutes each distributed over the driving period or immediately after this period in such a way as to comply with the provisions of paragraph 1.
3. During these breaks, the driver may not carry out any other work. For the purposes of this article, the waiting time and time not devoted to driving spent in a vehicle in motion, a ferry, or a train shall not be regarded as "other work".
4. The breaks observed under this article may not be regarded as daily rest periods.

Article 8¹¹

Rest periods

1. In each period of twenty-four hours, the driver shall have a daily rest period of at least eleven consecutive hours, which may be reduced to a minimum of nine consecutive hours not more than three times in any one week, on condition that an equivalent period of rest be granted as compensation before the end of the following week.

On days when the rest is not reduced in accordance with the first subparagraph, it may be taken in two or three separate periods during the twenty-four hour period, one of which must be of at least eight consecutive hours. In this case the minimum length of the rest shall be increased to twelve hours.

2. During each period of thirty hours when a vehicle is manned by at least two drivers, each driver shall have a rest period of not less than eight consecutive hours.
3. In the course of each week, one of the rest periods referred to in paragraphs 1 and 2 shall be extended by way of weekly rest, to a total of forty-five consecutive hours. This rest period may be reduced to a minimum of thirty-six consecutive hours if taken at the place where the vehicle is normally based or where the driver is based, or to a minimum of twenty-four consecutive hours if taken elsewhere. Each reduction shall be compensated by an equivalent rest taken en bloc before the end of the third week following the week in question.
4. A weekly rest period which begins in one week and continues into the following week may be attached to either of these weeks.
5. In the case of the carriage of passengers to which article 6 (1), fourth subparagraph, applies, the weekly rest period may be postponed until the week following that in respect of which the rest is due and added on to that second week's weekly rest.
6. Any rest taken as compensation for the reduction of the daily and/or weekly rest periods must be attached to another rest of at least eight hours and shall be granted, at the request of the person concerned, at the vehicle's parking place or driver's base.

¹¹ Modified by amendment 2.

7. The daily rest period may be taken in a vehicle, as long as it is fitted with a bunk and is stationary.

8. Notwithstanding the provisions in paragraph 1 above where a driver engaged in the carriage of goods or passengers accompanies a vehicle which is transported by ferryboat or train, the daily rest period may be interrupted not more than once, provided the following conditions are fulfilled:

- that part of the daily rest period spent on land must be able to be taken before or after the portion of the daily rest period taken on board the ferryboat or the train,
- the period between the two portions of the daily rest period must be as short as possible and may on no account exceed one hour before embarkation or after disembarkation, customs formalities being included in the embarkation or disembarkation operations,
- during both portions of the rest period the driver must be able to have access to a bunk or couchette.

The daily rest period, interrupted in this way, shall be increased by two hours.

Article 9¹²

Exceptions

Provided that road safety is not thereby jeopardized and to enable him to reach a suitable stopping place, the driver may depart from the provisions of this Agreement to the extent necessary to ensure the safety of persons, of the vehicle or of its load. The driver shall indicate the nature of and reason for his departure from those provisions on the record sheet of the control device or in his duty roster.

Article 10¹³

Control device

1. The Contracting Parties shall prescribe the installation and use on vehicles registered in their territory of a control device according to the requirements of this Agreement and the Annex and Appendices thereto.

2. The control device within the sense of this Agreement shall, as regards construction, installation, use and testing, comply with the requirements of this Agreement and the Annex and Appendices thereto.

3. A control device conforming to Council Regulation (EEC) No. 3821/85 of 20 December 1985 as regards construction, installation, use and testing shall be considered as conforming to the requirements of this Agreement and the Annex and Appendices thereto.

12 Modified by amendment 2.

13 Modified successively by amendments 1, 2, 3 and 5.

Article 11¹⁴

Supervision by the undertaking

1. The undertaking shall so organize road transport operations that crew members are able to comply with the provisions of this Agreement.
2. It shall make a regular check of driving periods, hours of other work and rest periods by referring to all documents at its disposal such as the individual control books. Should it discover any breach of this Agreement it shall take prompt action to end it and to avoid its repetition, for example by changing hours of work and routes.
3. Payments to wage-earning drivers, even in the form of bonuses or wage supplements, related to distances travelled and/or the amount of goods carried shall be prohibited, unless these payments are of such a kind as not to endanger road safety.

Article 12¹⁵

Measures of enforcement of the Agreement

1. Each Contracting Party shall adopt all appropriate measures to ensure observance of the provisions of this Agreement, in particular by an adequate level of roadside checks and checks performed on the premises of undertakings annually covering a large and representative proportion of drivers, undertakings and vehicles of all transport categories coming within the scope of this Agreement.
 - (a) The competent administrations of the Contracting Parties shall organize the checks so that:
 - During each calendar year a minimum of 1% of the days worked by the drivers of vehicles to which this Agreement applies shall be checked;
 - At least 15% of the total number of working days checked shall be checked on the roadside and at least 25% on the premises of undertakings;
 - (b) The elements of roadside checks shall include:
 - Daily driving periods, interruptions and daily rest periods and, if there are evident irregularities, the record sheets of the preceding days which shall be on board the vehicle;
 - The last weekly rest period, if appropriate;
 - The correct functioning of the control device.

14 Modified by amendment 2.

15 Modified by amendments 2 and 4.

These checks shall be carried out without discrimination of vehicles and drivers, whether resident or not.

(c) The elements of checks on the premises of undertakings shall include, apart from the elements subject to roadside checks, in addition to compliance with Article 10, paragraph 3:

- Weekly rest periods and driving periods between these rest periods;
- Two-weekly limits on hours of driving;
- Compensation for daily and weekly rest periods reduced in accordance with Article 8, paragraphs 1 and 3;
- Use of recording sheets and/or the organization of drivers' working time.

2. Within the framework of mutual assistance, the competent authorities of the Contracting Parties shall regularly send one another all available information concerning:

- Breaches of this Agreement committed by non-residents and any penalties imposed for such breaches;
- Penalties imposed by a Contracting Party on its residents for such breaches committed on the territory of other Contracting Parties.

In case of serious breaches, such information shall include the penalty imposed.

3. If the findings of a roadside check on the driver of a vehicle registered in the territory of another Contracting Party provide grounds to believe that infringements have been committed which cannot be detected during the check due to lack of necessary data, the competent authorities of the Contracting Parties concerned shall assist each other to clarify the situation. In cases where, to this end, the competent Contracting Party carries out a check at the premises of the undertaking, the results of this check shall be communicated to the other Party concerned.

4. Contracting Parties shall work in cooperation with each other in the organization of concerted roadside checks.

5. The United Nations Economic Commission for Europe shall issue a report every two years on the application by Contracting Parties of paragraph 1 of the present article.

Article 13¹⁶

Transitional provisions

1. All the new provisions of the present Agreement, including its Annex and Appendices 1B and 2, relating to the introduction of a digital control device, shall become mandatory for countries which are Contracting Parties to this Agreement at latest four years after the date of entry into force of the relevant amendments resulting from the procedure specified in article 21. In consequence, all

¹⁶ Modified successively by amendments 2 and 5.

vehicles covered by this Agreement, put into service for the first time after the expiry of this period, shall be equipped with a control device conforming to these new requirements. During this four-year period, Contracting Parties, which have not yet implemented these amendments in their countries, shall accept and control on their territory vehicles registered in another Contracting Party to this Agreement, which are already equipped with such a digital control device.

2. (a) The Contracting Parties shall take the necessary steps to be able to issue the driver cards referred to in the Annex to the present Agreement, as amended, at latest three months before the expiry of the four-year deadline referred to in paragraph 1. This minimum period of three months shall also be complied with in the event of the implementation by a Contracting Party of the provisions relating to the digital control device in conformity with Appendix 1B to this Annex before the expiry of the four-year deadline. Such Contracting Parties shall keep the secretariat of the Working Party on Road Transport of the Economic Commission for Europe informed of progress in the introduction of the digital control device in conformity with Appendix 1B to this Annex within its territory.

(b) Pending the issue by Contracting Parties of the cards referred to in (a), the provisions of article 14 of the Annex to this Agreement shall apply to drivers who may be required to drive vehicles fitted with a digital control device in accordance with Appendix 1B to this Annex.

3. Any instrument of ratification or accession deposited by a State after the entry into force of the amendments referred to in paragraph 1 shall be deemed to apply to the Agreement as amended, including the deadline for implementation specified in paragraph 1.

If accession takes place less than two years before the expiry of the deadline referred to in paragraph 1, the State shall inform the depositary of the date on which the digital control device will be brought into effective use in its territory when it deposits its instrument of ratification or accession. Such State may make use of a transitional period not exceeding two years from the date of entry into force of the Agreement for the State. The depositary shall so inform all Contracting Parties.

The provisions of the preceding paragraph shall also apply in the event of the accession of a State after the expiry of the four-year deadline for implementation referred to in paragraph 1.

Final provisions

Article 14

1. This Agreement shall be open for signature until 31 March 1971 and thereafter for accession, by States members of the Economic Commission for Europe and States admitted to the Commission in a consultative capacity under paragraph 8 of the Commission's terms of reference.
2. This Agreement shall be ratified.
3. The instruments of ratification or accession shall be deposited with the Secretary-General of the United Nations.
4. This Agreement shall enter into force on the one hundred and eightieth day after the date of deposit of the eighth instrument of ratification or accession.
5. In respect of each State which ratifies, or accedes to, this Agreement after the deposit of the eighth instrument of ratification or accession as referred to in paragraph 4 of this article, the Agreement shall enter into force one hundred and eighty days after the deposit by that State of its instrument of ratification or accession.

Article 15

1. Any Contracting Party may denounce this Agreement by notice addressed to the Secretary-General of the United Nations.
2. The denunciation shall take effect six months after the date on which the Secretary-General receives notice thereof.

Article 16

This Agreement shall cease to have effect if for any period of twelve consecutive months after its entry into force the number of Contracting Parties is less than three.

Article 17¹⁷

1. Any State may, at the time of signing this Agreement or of depositing its instrument of ratification or accession or at any time thereafter, declare by notification addressed to the Secretary-General of the United Nations that the validity of the Agreement shall be extended to all or any of the territories for the international relations of which it is responsible. The Agreement shall apply to the territory or territories named in the notification as from the one hundred and eightieth day after receipt of the notification by the Secretary-General or, if on that day the Agreement has not yet entered into force, as from the date of its entry into force.

17 Modified by amendment 2.

2. Any State which has made a declaration under the preceding paragraph making this Agreement applicable to a territory for whose international relations it is responsible may denounce the Agreement separately in respect of that territory in conformity with the provisions of article 15 hereof.

Article 18

1. Any dispute between two or more Contracting Parties concerning the interpretation or application of this Agreement shall so far as possible be settled by negotiation between them.

2. Any dispute which is not settled by negotiation shall be submitted to arbitration if any one of the Contracting Parties concerned in the dispute so requests and shall accordingly be referred to one or more arbitrators selected by agreement between the Parties in dispute. If within three months from the date of the request for arbitration the Parties in dispute are unable to agree on the selection of an arbitrator or arbitrators, any of those Parties may request the Secretary-General of the United Nations to appoint a single arbitrator to whom the dispute shall be referred for decision.

3. The decision of the arbitrator or arbitrators appointed under the preceding paragraph shall be binding on the Contracting Parties in dispute.

Article 19¹⁸

1. Any State may, at the time of signing, ratifying, or acceding to this Agreement, declare that it does not consider itself bound by article 18, paragraphs 2 and 3 hereof. The other Contracting Parties shall not be bound by the said paragraphs with respect to any Contracting Party which has entered such a reservation.

2. If at the time of depositing its instrument of ratification or accession a State enters a reservation other than that provided for in paragraph 1 of this article, the Secretary-General of the United Nations shall communicate the reservation to the States which have previously deposited their instruments of ratification or accession and have not since denounced this Agreement. The reservation shall be deemed to be accepted if none of the said States has, within six months after such communication, expressed its opposition to acceptance of the reservation. Otherwise the reservation shall not be admitted, and, if the State which entered the reservation does not withdraw it the deposit of that State's instrument of ratification or accession shall be without effect. For the purpose of the application of this paragraph the opposition of States whose accession or ratification is, in virtue of this paragraph without effect by reason of reservations entered by them, shall be disregarded.

3. Any Contracting Party whose reservation has been adopted in the Protocol of signature of this Agreement or who has entered a reservation pursuant to paragraph 1 of this article, or made a reservation which has been accepted pursuant to paragraph 2 of this article may at any time withdraw such reservation by a notification addressed to the Secretary-General.

¹⁸ Modified by amendment 2.

Article 20¹⁹

1. After this Agreement has been in force for three years any Contracting Party may, by a notification addressed to the Secretary-General of the United Nations, request that a conference be convened for the purpose of revising the Agreement. The Secretary-General shall notify all Contracting Parties of the request and shall convene a revision conference if not less than one-third of the Contracting Parties signify their assent to the request within a period of four months from the date of the notification by the Secretary-General.
2. If a conference is convened in conformity with the preceding paragraph the Secretary-General shall notify all the Contracting Parties and invite them to submit within a period of three months such proposals as they wish the conference to consider. The Secretary-General shall circulate to all Contracting Parties the provisional agenda for the conference, together with the text of such proposals, not less than three months before the date on which the conference is to meet.
3. The Secretary-General shall invite to any conference convened under this article all the States referred to in article 14, paragraph 1, of this Agreement.

Article 21²⁰

1. Any Contracting Party may propose one or more amendments to this Agreement. The text of any proposed amendment shall be communicated to the Secretary-General of the United Nations, who shall communicate it to all Contracting Parties and inform thereof all the other States referred to in article 14, paragraph 1, of this Agreement.
2. Within a period of six months from the date on which the proposed amendment is communicated by the Secretary-General, any Contracting Party may inform the Secretary-General:
 - (a) that it has an objection to the amendment proposed; or
 - (b) that, although it intends to accept the proposal, the conditions necessary for such acceptance are not yet fulfilled in its State.
3. If a Contracting Party sends to the Secretary-General a communication such as is provided for in paragraph 2 (b) of this article, it may, so long as it has not notified the Secretary-General of its acceptance of the proposed amendment, submit an objection to the proposed amendment within a period of nine months following the expiry of the six-month period provided for its communication.
4. If an objection to the proposed amendment is stated in accordance with the terms of paragraphs 2 and 3 of this article, the amendment shall be deemed not to have been accepted and shall be of no effect.
5. If no objection to the proposed amendment has been stated under paragraphs 2 and 3 of this article, then the amendment shall be deemed to have been accepted as from the date specified below:

19 Modified by amendment 2.

20 Modified by amendments 2 and 5.

(a) if no Contracting Party has sent a communication to the Secretary-General under paragraph 2 (b) of this article: on the expiry of the period of six months referred to in paragraph 2 of this article;

(b) if any Contracting Party has sent a communication to the Secretary-General under paragraph 2 (b) of this article: on the earlier of the following two dates:

n the date by which all the Contracting Parties which sent such communications have notified the Secretary-General of their acceptance of the proposal, subject to the proviso that, if all the acceptances were notified before the expiry of the period of six months referred to in paragraph 2 of this article, this date shall be taken to be the date of expiry of the said six-month period;

n the date of expiry of the period of nine months referred to in paragraph 3 of this article.

5 bis In the case of a country which becomes a Contracting Party to this Agreement between the moment of notification of a draft amendment and the moment when it is considered accepted, the secretariat of the Working Party on Road Transport of the Economic Commission for Europe shall notify the new State Party of the draft amendment as soon as possible. The latter may inform the Secretary-General of any objection before the end of the six-month period from the date of transmission of the original amendment to all Contracting Parties.

6. Any amendment deemed to be accepted shall enter into force three months after the date on which it was deemed to be accepted.

7. The Secretary-General shall as soon as possible notify all Contracting Parties whether an objection to the proposed amendment has been stated under paragraph 2 (a) of this article and whether he has received from one or more Contracting Parties a communication under paragraph 2 (b) of this article. If he has received such a communication from one or more Contracting Parties, he shall subsequently inform all the Contracting Parties whether the Contracting Party or Parties which have made such a communication raise an objection to or accept the proposed amendment.

8. Independently of the amendment procedure laid down in paragraphs 1 to 6 of this article, the annex to this Agreement may be modified by agreement between the competent administrations of all the Contracting Parties; if the competent administration of a Contracting Party has stated that under its domestic law its agreement is contingent on special authorization for the purpose, or on the approval of a legislative body, the consent of the competent administration of the Contracting Party concerned to the modification of the annex shall not be deemed to have been given until the said competent administration has notified the Secretary-General that the necessary authorization or approval has been obtained. The agreement between the competent administrations shall appoint the date of entry into force of the modified annex, and may provide that, during a transitional period, the old annex shall remain in force, wholly or in part, concurrently with the modified annex.

Article 22²¹

1. Appendices 1 and 2 to the annex to this Agreement may be amended by the procedure specified in this article.
 2. At the request of a Contracting Party, any amendments proposed to appendices 1 and 2 to the annex to this Agreement shall be considered by the Principal Working Party on Road Transport of the Economic Commission for Europe.
 3. If it is adopted by the majority of the members present and voting, and if this majority includes the majority of the Contracting Parties present and voting, the amendment shall be communicated by the Secretary-General to the competent administrations of all the Contracting Parties for acceptance.
 4. The amendment shall be accepted if, within a period of six months following the date of notification, less than one third of the competent administrations of the Contracting Parties notify the Secretary-General of their objection to the amendment.
- 4 bis.* In the case of a country which becomes a Party to this Agreement between the moment of notification of a draft amendment and the moment when it is considered accepted, the secretariat of the Working Party on Road Transport of the Economic Commission for Europe shall notify the new State Party of the draft amendment as soon as possible. The latter may inform the Secretary-General of any objection before the end of the six-month period from the date of transmission of the original amendment to all Contracting Parties.
5. Any amendment accepted shall be communicated by the Secretary-General to all the Contracting Parties and shall come into force three months after the date of its notification.

Article 22 *bis*²²

Procedure for the amendment of Appendix 1B

1. Appendix 1B of the Annex to the present Agreement shall be amended according to the procedure defined in the present article.
2. Any amendment proposal to the introductory articles of Appendix 1B shall be adopted by the Working Party on Road Transport of the Economic Commission for Europe by a majority of the Contracting Parties present and voting. Any amendment thus adopted will be transmitted by the secretariat of the Working Party to the Secretary-General for notification to all Contracting Parties. It shall enter into force three months after the date of notification to Contracting Parties.

²¹ Introduced by amendment 2, then modified by amendment 5.

²² Introduced by amendment 5.

3. Appendix 1B, adapted for the present Agreement from Annex IB *of Regulation (EEC) 3821/85 as cited in article 10 of the present Agreement, depending directly on evolutions introduced into this Annex by the European Union, any amendment made to this Annex shall be applicable to Appendix 1B under the following conditions:

- the secretariat of the Working Party on Road Transport of the Economic Commission for Europe will officially inform the competent authorities of all Contracting Parties of the publication in the Official Journal of the European Communities of the amendments introduced to Annex IB of the Community Regulation and at the same time will communicate this information to the Secretary-General accompanied by a copy of the relevant texts.
- these amendments shall enter directly into force for Appendix 1B three months after the date of communication to Contracting Parties of the information.

4. When a proposal to amend the Annex to the present Agreement also implies an amendment to Appendix 1B, the amendments concerning the Appendix may not enter into force before those concerning the Annex. When, in this framework, amendments to Appendix 1B are presented at the same time as amendments to the Annex, their date of entry into force shall be determined by the date resulting from application of the procedures outlined in article 21.

Article 23²³

In addition to the notifications referred to in articles 20 and 21 of this Agreement, the Secretary-General of the United Nations shall notify the States referred to in article 14, paragraph 1, hereof of:

- (a) ratifications or accessions under article 14 of this Agreement;
- (b) the dates of entry into force of the present Agreement, in conformity with article 14 hereof;
- (c) denunciations under article 15 of this Agreement;
- (d) the termination of this Agreement in conformity with article 16 hereof;
- (e) notifications received under article 17 of this Agreement;
- (f) declarations and notifications received under article 19 of this Agreement;
- (g) the entry into force of any amendment in conformity with article 21 of this Agreement.

* As last amended by Commission Regulations (EC) No.1360/2002 of 13 June 2002 (OJ L 207 of 5 August 2002 (corrigendum OJ L 77 of 13 March 2004)) and No. 432/2004 of 5 March 2004 (OJ L 71 of 10 March 2004).

23 Modified by amendment 2.

Article 24

The Protocol of signature of this Agreement shall have the same force, validity and duration as the Agreement itself, of which it shall be deemed to be an integral part.

Article 25²⁴

After 31 March 1971 the original of this Agreement shall be deposited with the Secretary-General of the United Nations, who shall transmit certified true copies to each of the States referred to in article 14, paragraph 1, hereof.

24 Modified by amendment 2.

ANNEX²⁵

CONTROL DEVICE

GENERAL PROVISIONS

Chapter I: Type approval

Article 1

For the purposes of this Chapter, the words “control device” shall mean “control device or its components”.

Applications for the approval of a type of control device or of a model record sheet or memory card shall be submitted, accompanied by the appropriate specifications, by the manufacturer or his agent to a Contracting Party. No application in respect of any one type of control device or of any one model record sheet or memory card may be submitted to more than one Contracting Party.

Article 2

A Contracting Party shall grant its type approval to any type of control device, to any model record sheet or memory card which conforms to the requirements laid down in Appendix 1 or 1B to this Annex, provided that the Contracting Party is in a position to check that production models conform to the approved prototype.

The control device referred to in Appendix 1B may not be granted type approval until the whole system (the control device itself, driver card and electrical gearbox connections) has demonstrated its capacity to resist attempts to tamper with or alter the data on driving times. The tests necessary to establish this shall be carried out by experts familiar with up-to-date tampering techniques.

Any modifications or additions to an approved model must receive additional type approval from the Contracting Party which granted the original type approval.

Article 3

Contracting Parties shall issue to the applicant an approval mark, which shall conform to the model shown in Appendix 2, for each type of control device or model record sheet or memory card which they approve pursuant to article 2.

Article 4

The competent authorities of the Contracting Party to which the application for type approval has been submitted shall, in respect of each type of control device or model record sheet or memory card which they approve or refuse to approve, either send within one month to the authorities of the other Contracting Parties a copy of the approval certificate accompanied by copies of the relevant specifications, or, if such is the case, notify those authorities that approval has been refused; in cases of refusal they shall communicate the reasons for their decision.

²⁵ Modified by amendment 2, then completely revised by amendment 5.

Article 5

1. If a Contracting Party which has granted type approval as provided for in article 2 finds that a certain control device or record sheet or memory card bearing the type approval mark which it has issued does not conform to the prototype which it has approved, it shall take the necessary measures to ensure that production models conform to the approved prototype. The measures taken may, if necessary, extend to withdrawal of the type approval.
2. A Contracting Party which has granted type approval shall withdraw such approval if the control device or record sheet or memory card which has been approved is not in conformity with this Annex or its Appendices or displays in use any general defect which makes it unsuitable for the purpose for which it is intended.
3. If a Contracting Party which has granted type approval is notified by another Contracting Party of one of the cases referred to in paragraphs 1 and 2, it shall also, after consulting the latter Contracting Party, take the steps laid down in those paragraphs, subject to paragraph 5.
4. A Contracting Party which ascertains that one of the cases referred to in paragraph 2 has arisen may forbid until further notice the placing on the market and putting into service of the control device or record sheets or memory card. The same applies in the cases mentioned in paragraph 1 with respect to control devices or record sheets or memory cards which have been exempted from the initial verification, if the manufacturer, after due warning, does not bring the equipment into line with the approved model or with the requirements of this Annex.

In any event, the competent authorities of the Contracting Parties shall notify one another within one month, of any withdrawal of type approval or of any other measures taken pursuant to paragraphs 1, 2 and 3 and shall specify the reasons for such action.

5. If a Contracting Party which has granted type approval disputes the existence of any of the cases specified in paragraphs 1 or 2 notified to it, the Contracting Parties concerned shall endeavour to settle the dispute.

Article 6

1. An applicant for type approval of a model record sheet shall state on his application the type or types of control device on which the sheet in question is designed to be used and shall provide a suitable device of such type or types for the purpose of testing the sheet.
2. The competent authorities of each Contracting Party shall indicate on the approval certificate for the model record sheet the type or types of control device on which that model sheet may be used.

Article 7

No Contracting Party may refuse to register any vehicle fitted with a control device, or prohibit the entry into service or use of such vehicle for any reason connected with the fact that the vehicle is fitted with such device, if the control device bears the approval mark referred to in article 3 and the installation plaque referred to in article 9.

Article 8

All decisions pursuant to this Annex refusing or withdrawing approval of a type of control device or model record sheet or memory card shall specify in detail the reasons on which they are based. A decision shall be communicated to the party concerned, who shall at the same time be informed of the remedies available to him under the laws of the Contracting Party and of the time limits for the exercise of such remedies.

Chapter II - Installation and inspection

Article 9

1. The control device may be installed or repaired only by fitters or workshops approved by the competent authorities of Contracting Parties for that purpose after the latter, should they so desire, have heard the views of the manufacturers concerned.

The period of administrative validity of approved workshop and fitter cards shall not exceed one year.

If a card issued to an approved workshop or fitter is to be extended, is damaged, malfunctions, is lost or stolen, the authority shall supply a replacement card within five working days of receiving a detailed request to that effect.

Where a new card is issued to replace an old one, the new card shall bear the same "workshop" information number, but the index shall be increased by one. The authority issuing the card shall maintain a register of lost, stolen or defective cards.

Contracting Parties shall take any measure necessary to prevent the cards distributed to approved fitters and workshops from being falsified.

2. The approved fitter or workshop shall place a special mark on the seals which it affixes and, in addition, shall enter for a control device in conformity with Appendix 1B, the electronic security data for carrying out, in particular, the authentication checks. The competent authorities of each Contracting Party shall maintain a register of the marks and electronic security data used and of approved workshop and fitter cards issued.

3. The competent authorities of the Contracting Parties shall send each other their lists of approved fitters and workshops and the cards issued to them and also copies of the marks and of the necessary information relating to the electronic security data used.

4. For the purpose of certifying that installation of the control device took place in accordance with the requirements of this Annex an installation plaque affixed as provided in Appendix 1 or 1B shall be used.

5. Seals may be removed by fitters or workshops approved by the competent authorities in accordance with the provisions of paragraph 1 of this article or in the circumstances described in Appendix 1 or 1B of this Annex.

Chapter III - Use of equipment

Article 10

The employer and drivers shall ensure the correct functioning and proper use of, on the one hand, the control device and, on the other, the driver card where a driver is required to drive a vehicle fitted with a control device in conformity with Appendix 1B.

Article 11

1. The employer shall issue a sufficient number of record sheets to drivers of vehicles fitted with the control device in conformity with Appendix 1, bearing in mind the fact that these sheets are personal in character, the length of the period of service, and the possible obligation to replace sheets which are damaged, or have been taken by an authorized inspecting officer. The employer shall issue to drivers only sheets of an approved model suitable for use in the control device installed in the vehicle.

Where the vehicle is fitted with a control device in conformity with Appendix 1B, the employer and the driver shall ensure that, taking into account the length of the period of service, the printing on request referred to in Appendix 1B can be carried out correctly in the event of an inspection.

2. The undertaking shall keep the record sheets in good order for at least a year after their use and shall give copies to the drivers concerned who request them. The sheets shall be produced or handed over at the request of any authorized inspecting officer.

3. The driver card as defined in Appendix 1B shall be issued, at the request of the driver, by the competent authority of the Contracting Party where the driver has his normal residence.

A Contracting Party may require any driver subject to the provisions of the Agreement and normally resident on its territory to hold a driver card.

(a) For the purposes of this Agreement 'normal residence' means the place where a person usually lives, that is for at least 185 days in each calendar year, because of personal and occupational ties, or, in the case of a person with no occupational ties, because of personal ties which show close links between that person and the place where he is living.

However, the normal residence of a person whose occupational ties are in a different place from his personal ties and who consequently lives in turn in different places situated in two or more Contracting Parties shall be regarded as being the place of his personal ties, provided that such person returns there regularly. This last condition need not be met where the person is living in a Contracting Party in order to carry out a fixed-term assignment.

(b) Drivers shall give proof of their place of normal residence by any appropriate means, such as their identity card or any other valid document.

(c) Where the competent authorities of the Contracting Party issuing the driver card have doubts as to the validity of a statement as to normal residence made in accordance with point (b), or for the purpose of certain specific controls, they may request any additional information or evidence.

(d) The competent authority of the issuing Contracting Party shall, as far as this can be done, ensure that the applicant does not already hold a valid driver card.

4. (a) The competent authority of the Contracting Party shall personalize the driver card in accordance with the provisions of Appendix 1B.

The period of administrative validity of the driver card shall not exceed five years.

The driver may hold one valid driver card only. The driver is authorized to use only his own personalized driver card. The driver shall not use a driver card which is defective or which has expired.

When a driver card is issued replacing an old one, the new card shall bear the same driver card issue number but the index shall be increased by one. The issuing authority shall keep records of issued, stolen, lost or defective driver cards for a period at least equivalent to their period of validity.

If the driver card is damaged, malfunctions or is lost or stolen, the authority shall supply a replacement card within five working days of receiving a detailed request to that effect.

In the event of a request for the renewal of a card whose expiry date is approaching, the authority shall supply a new card before the expiry date provided that the request was sent to it within the time limits laid down in the fourth subparagraph of article 12 (1).

(b) Driver cards shall be issued only to applicants who are subject to the provisions of the Agreement.

(c) The driver card shall be personal. It may not, during its official period of validity, be withdrawn or suspended for whatever reason unless the competent authority of a Contracting Party finds that the card has been falsified, or the driver is using a card of which he is not the holder, or that the card held has been obtained on the basis of false declarations and/or forged documents. If such suspension or withdrawal measures are taken by a Contracting Party other than the Contracting Party of issue, the former shall return the card to the authorities of the Contracting Party which issued it and shall indicate the reasons for returning it.

(d) Driver cards issued by Contracting Parties shall be mutually recognized.

Where the holder of a valid driver card issued by a Contracting Party has established his normal place of residence in another Contracting Party, he may ask for his card to be exchanged for an equivalent driver card; it shall be the responsibility of the Contracting Party which carries out the exchange to verify if necessary whether the card produced is actually still valid.

Contracting Parties carrying out an exchange shall return the old card to the authorities of the Contracting Party of issue and indicate the reasons for so doing.

(e) Where a Contracting Party replaces or exchanges a driver card, the replacement or exchange, and any subsequent replacement or renewal, shall be registered in that Contracting Party.

(f) Contracting Parties shall take all the necessary measures to prevent any possibility of driver cards being falsified.

5. Contracting Parties shall ensure that data needed to monitor compliance with the present Agreement which are recorded and stored by the control device in conformity with Appendix 1B to this Annex can be stored for 365 days after the date of their recording and that they can be made available under conditions that guarantee the security and accuracy of the data.

Contracting Parties shall take any measures necessary to ensure that the resale or decommissioning of a control device cannot detract, in particular, from the satisfactory application of this paragraph.

Article 12

1. Drivers shall not use dirty or damaged record sheets or driver card. The sheets or driver card shall be adequately protected on this account.

In case of damage to a sheet or driver card bearing recordings, drivers shall attach the damaged sheet or driver card to a spare sheet or a temporary sheet used to replace it.

If the driver card is damaged, malfunctions or is lost or stolen, the driver shall apply within seven calendar days for its replacement to the competent authorities of the Contracting Party in which he has his normal residence.

Where a driver wishes to renew his driver card, he shall apply to the competent authorities of the Contracting Party in which he has his normal residence not later than 15 working days before the expiry date of the card.

2. Drivers shall use the record sheets or driver card every day on which they are driving, starting from the moment they take over the vehicle. The record sheet or driver card shall not be withdrawn before the end of the daily working period unless its withdrawal is otherwise authorized. No record sheet or driver card may be used to cover a period longer than that for which it is intended.

When, as a result of being away from the vehicle, a driver is unable to use the control device fitted to the vehicle, the periods of time indicated in paragraph 3, second indent (b), (c) and (d) below shall be entered on the sheet, either manually, by automatic recording or other means, legibly and without dirtying the sheet.

Drivers shall amend the record sheets as necessary should there be more than one driver on board the vehicle, so that the information referred to in paragraph 3 second indent (b), (c) and (d) below is recorded on the record sheet of the driver who is actually driving.



3. Drivers shall:



- ensure that the time recorded on the sheet agrees with the official time in the country

of registration of the vehicle,



- operate the switch mechanisms enabling the following periods of time to be recorded separately and distinctly:

(a) under the sign  or ²⁶ driving time;

(b) under the sign  or ²⁷ all other periods of work;

(c) under the sign  or ²⁸ other periods of availability, namely:

- waiting time, i.e. the period during which drivers need remain at their posts only for the purpose of answering any calls to start or resume driving or to carry out other work,
- time spent beside the driver while the vehicle is in motion,
- time spent on a bunk while the vehicle is in motion;

(d) under the sign  or ²⁹ breaks in work and daily rest periods.

4. Each Contracting Party may permit all the periods referred to in paragraph 3, second indent (b) and (c) to be recorded under the sign  on the record sheets used on vehicles registered in its territory.

5. Each crew member concerned shall enter the following information on his record sheet:

(a) on beginning to use the sheet - his surname and first name;

(b) the date and place where use of the sheet begins and the date and place where such use ends;

(c) the registration number of each vehicle to which he is assigned, both at the start of the first journey recorded on the sheet and then, in the event of a change of vehicle, during use of the sheet;

(d) the odometer reading:

- at the start of the first journey recorded on the sheet,
- at the end of the last journey recorded on the sheet,
- in the event of a change of vehicle during a working day (reading on the vehicle to

26 Symbols used for the digital tachograph.

27 Symbols used for the digital tachograph.

28 Symbols used for the digital tachograph.

29 Symbols used for the digital tachograph.

which he was assigned and reading on the vehicle to which he is assigned);

- (e) if relevant, the time of any change of vehicle.

5 *bis*. The driver shall enter in the control device in conformity with Appendix 1B the symbols of the countries in which he begins and ends his daily work period.

The above data entries shall be activated by the driver, and may be entirely manual or automatic if the control device is linked to a satellite tracking system.

6. The control device defined in Appendix 1 shall be so designed that it is possible for an authorized inspecting officer, if necessary after opening the equipment, to read the recordings relating to the nine hours preceding the time of the check without permanently deforming, damaging or soiling the sheet.

The device shall, furthermore, be so designed that it is possible, without opening the case, to verify that recordings are being made.

7. (a) Where the driver drives a vehicle fitted with a control device in conformity with Appendix 1, he must be able to produce, whenever an inspecting officer so requests:

- the record sheets for the current week and, in any event, the sheet for the last day on which he drove during the previous week,
- the driver card if he holds one, and
- print-outs from the control device defined in Appendix 1B relating to the periods of time indicated in paragraph 3, second indent, (a), (b), (c) and (d) if he drove a vehicle fitted with such a control device during the period referred to in the first indent of this paragraph.

(b) Where the driver drives a vehicle fitted with a control device in conformity with Appendix 1B, he must be able to produce, whenever an inspecting officer so requests:

- the driver card of which he is the holder and,
- the record sheets corresponding to the same period as the one referred to in the first indent of subparagraph (a) during which he drove a vehicle fitted with a control device in conformity with Appendix 1.

(c) An authorized inspecting officer may check compliance with the Agreement by analysis of the record sheets, of the displayed or printed data which have been recorded by the control device or by the driver card or, failing this, by analysis of any other supporting document that justifies non-compliance with a provision, such as those laid down in article 13 (2) and (3).

8. It shall be forbidden to falsify, suppress or destroy data recorded on the record sheet, stored in the control device or on the driver card, or print-outs from the control device as defined in Appendix 1B. The same applies to any manipulation of the control device, record sheet or driver

card which may result in data and/or printed information being falsified, suppressed or destroyed. No device which could be used to carry out the manipulations mentioned shall be present on the vehicle.

Article 13

1. In the event of breakdown or faulty operation of the control device, the employer shall have it repaired by an approved fitter or workshop, as soon as circumstances permit.

If the vehicle is unable to return to the premises within a period of one week calculated from the day of the break-down or of the discovery of defective operation, the repair shall be carried out en route.

Measures taken by the Contracting Parties may give the competent authorities power to prohibit the use of the vehicle in cases where breakdown or faulty operation has not been put right as provided in the foregoing subparagraphs.

2. While the device is unserviceable or malfunctioning, drivers shall mark on the record sheet or sheets, or on a temporary sheet to be attached to the record sheet or to the driver card, on which he shall enter data enabling him to be identified (name and number of his driving licence or name and number of his driver card), including his signature, all information for the various periods of time which are no longer recorded or printed out correctly by the control device.

If a driver card is damaged, malfunctions or is lost or stolen, the driver shall, at the end of his journey, print out the information relating to the periods of time recorded by the control device and mark on that document the details that enable him to be identified (name and number of his driving licence or name and number of his driver card), including his signature.

3. If a driver card is damaged or if it malfunctions, the driver shall return it to the competent authority of the Contracting Party in which he has his normal residence. Theft of the driver card shall be the subject of a formal declaration to the competent authorities of the State where the theft occurred.

Loss of the driver card must be reported in a formal declaration to the competent authorities of the Contracting Party that issued it and to the competent authorities of the Contracting Party of normal residence where they are different.

The driver may continue to drive without a driver card for a maximum period of 15 calendar days or for a longer period if this is necessary for the vehicle to return to its premises, provided he can prove the impossibility of producing or using the card during this period.

Where the authorities of the Contracting Party in which the driver has his normal residence are different from those which issued his card and where the latter are requested to renew, replace or exchange the driver card, they shall inform the authorities which issued the old card of the precise reasons for its renewal, replacement or exchange.

Article 14

1. Pursuant to article 13, paragraph 2 (b) of the Agreement, drivers who are driving a vehicle

registered in a Contracting Party and to whom the competent authorities have not yet been able to issue the driver cards and who, during the transitional period referred to in paragraph 1 of this article, drive in international traffic with a vehicle fitted with a digital control device in accordance with Appendix 1B to the Annex, must be able to produce, whenever an inspecting officer so requests, the printouts and/or the record sheets for the current week and, in any event, the printout and/or record sheet for the last day on which he drove during the previous week.

2. Paragraph 1 does not apply to drivers of vehicles registered in a country where it is obligatory to use a driver card. However, drivers shall produce printouts whenever an inspecting officer so requests.

3. The printouts referred to in paragraph 1 shall be marked with the details that enable the drivers to be identified (name and number of the driving licence), including their signature.”

Annex - Appendix 1³⁰

REQUIREMENTS FOR CONSTRUCTION, TESTING, INSTALLATION AND INSPECTION

I. DEFINITIONS

In this appendix

(a) “control device” means equipment intended for installation in road vehicles to show and record automatically or semi-automatically details of the movement of those vehicles and of certain working periods of their drivers;

(b) “record sheet” means a sheet designed to accept and retain recorded data, to be placed in the control device and on which the marking devices of the latter inscribe a continuous record of the information to be recorded;

(c) “constant of the control device” means the numerical characteristic giving the value of the input signal required to show and record a distance travelled of 1 kilometre; this constant must be expressed either in revolutions per kilometre ($k = \dots \text{ rev/km}$), or in impulses per kilometre ($k = \dots \text{ imp/km}$);

(d) “characteristic coefficient of the vehicle” means the numerical characteristic giving the value of the output signal emitted by the part of the vehicle linking it with the control device (gearbox output shaft or axle) while the vehicle travels a distance of one measured kilometre under normal test conditions (see chapter VI, paragraph 4 of this appendix). The characteristic coefficient is expressed either in revolutions per kilometre ($W = \text{rev/km}$) or in impulses per kilometre ($W = \dots \text{ imp/km}$);

(e) “effective circumference of wheel tyres” means the average of the distances travelled by the several wheels moving the vehicle (driving wheels) in the course of one complete rotation. The measurement of these distances must be made under normal test conditions (see chapter VI, paragraph 4 of this appendix) and is expressed in the form: $l = \dots \text{ mm}$.

II. GENERAL CHARACTERISTICS AND FUNCTIONS OF CONTROL DEVICE

The control device must be able to record the following:

1. distance travelled by the vehicle;
2. speed of the vehicle;
3. driving time;
4. other periods of work or of availability;

³⁰ Modified by amendment 2.

5. breaks from work and daily rest periods;
6. opening of the case containing the record sheet;
7. for electronic control device which is device operating by signals transmitted electrically from the distance and speed sensor, any interruption exceeding 100 milliseconds in the power supply of the recording equipment (except lighting), in the power supply of the distance and speed sensor and any interruption in the signal lead to the distance and speed sensor.

For vehicles used by two drivers the control device must be capable of recording simultaneously but distinctly and on two separate sheets details of the periods listed under 3, 4 and 5.

III. CONSTRUCTION REQUIREMENTS FOR CONTROL DEVICE

A. GENERAL POINTS

1. Control device shall include the following:

(a) Visual instruments showing:

- distance travelled (distance recorder),
- speed (speedometer),
- time (clock).

(b) Recording instruments comprising:

- a recorder of the distance travelled,
- a speed recorder,
- one or more time recorders satisfying the requirements laid down in chapter III C 4.

(c) A means of marking showing on the record sheet individually:

- each opening of the case containing that sheet,
- for electronic control device, as defined in point 7 of chapter II, any interruption exceeding 100 milliseconds in the power supply of the control device (except lighting), not later than at switching-on the power supply again,
- for electronic control device, as defined in point 7 of chapter II, any interruption exceeding 100 milliseconds in the power supply of the distance

and speed sensor and any interruption in the signal lead to the distance and speed sensor.

2. Any inclusion of the equipment of devices additional to those listed above must not interfere with the proper operation of the mandatory devices or with the reading of them.

The control device must be submitted for approval complete with any such additional devices.

3. Materials

(a) All the constituent parts of the control device must be made of materials with sufficient stability and mechanical strength and stable electrical and magnetic characteristics.

(b) Any modification in a constituent part of the control device or in the nature of the materials used for its manufacture must, before being applied in manufacture, be submitted for approval to the authority which granted type-approval for the control device.

4. Measurement of distance travelled

The distances travelled may be measured and recorded either:

- so as to include both forward and reverse movement, or
- so as to include only forward movement.

Any recording of reversing movements must on no account affect the clarity and accuracy of the other recordings.

5. Measurement of speed

(a) The range of speed measurement shall be as stated in the type-approval certificate.

(b) The natural frequency and the damping of the measuring device must be such that the instruments showing and recording the speed can, within the range of measurement, follow acceleration changes of up to 2 m/s^2 , within the limits of accepted tolerances.

6. Measurement of time (clock)

(a) The control of the mechanism for resetting the clock must be located inside a case containing the record sheet; each opening of that case must be automatically recorded on the record sheet.

(b) If the forward movement mechanism of the record sheet is controlled by the clock, the period during which the latter will run correctly after being fully wound must be greater by at least 10% than the recording period corresponding to the maximum sheet-load of the equipment.

7. Lighting and protection

(a) The visual instruments of the control device must be provided with adequate non-dazzling lighting.

(b) For normal conditions of use, all the internal parts of the control device must be protected against damp and dust. In addition they must be made proof against tampering by means of casings capable of being sealed.

B. VISUAL INSTRUMENTS

1. Distance travelled indicator (distance recorder)

(a) The value of the smallest grading on the control device showing distance travelled must be 0.1 kilometres. Figures showing hectometres must be clearly distinguishable from those showing whole kilometres.

(b) The figures on the distance recorder must be clearly legible and must have an apparent height of at least 4 mm.

(c) The distance recorder must be capable of reading up to at least 99,999.9 kilometres.

2. Speed indicators (speedometer)

(a) Within the range of measurement, the speed scale must be uniformly graduated by 1, 2, 5 or 10 kilometres per hour. The value of a speed graduation (space between two successive marks) must not exceed 10% of the maximum speed shown on the scale.

(b) The range indicated beyond that measured need not be marked by figures.

(c) The length of each space on the scale representing a speed difference of 10 kilometres per hour must not be less than 10 millimetres.

(d) On an indicator with a needle, the distance between the needle and the control device face must not exceed 3 millimetres.

3. Time indicator (clock)

The time indicator must be visible from outside control device and give a clear, plain and unambiguous reading.

C. RECORDING INSTRUMENTS

1. General points

(a) All equipment, whatever the form of the record sheet (strip or disc) must be provided with a mark enabling the record sheet to be inserted correctly, in such a way as to ensure that the time shown by the clock and the time-marking on the sheet correspond.

(b) The mechanism moving the record sheet must be such as to ensure that the latter moves without play and can be freely inserted and removed.

(c) For record sheets in disc form, the forward movement device must be controlled by the clock mechanism. In this case, the rotating movement of the sheet must be continuous and uniform, with a minimum speed of 7 millimetres per hour measured at the inner border of the ring marking the edge of the speed recording area.

In equipment of the strip type, where the forward movement device of the sheets is controlled by the clock mechanism the speed of rectilinear forward movement must be at least 10 millimetres per hour.

(d) Recording of the distance travelled, of the speed of the vehicle and of any opening of the case containing the record sheet or sheets must be automatic.

2. Recording distance travelled

(a) Every kilometre of distance travelled must be represented on the record by a variation of at least 1 millimetre on the corresponding coordinate.

(b) Even at speeds reaching the upper limit of the range of measurement, the record of distances must still be clearly legible.

3. Recording speed

(a) Whatever the form of the record sheet, the speed recording stylus must normally move in a straight line and at right angles to the direction of travel of the record sheet.





However, the movement of the stylus may be curvilinear, provided the following conditions are satisfied:

- the trace drawn by the stylus must be perpendicular to the average circumference (in the case of sheets in disc form) or to the axis (in the case of sheets in strip form) of the area reserved for speed recording,
- the ratio between the radius of curvature of the trace drawn by the stylus and the width of the area reserved for speed recording must be not less than 2.4 to 1 whatever the form of the record sheet,
- the markings on the timescale must cross the recording area in a curve of the same radius as the trace drawn by the stylus. The spaces between the markings on the timescale must represent a period not exceeding one hour.

(b) Each variation in speed of 10 kilometres per hour must be represented on the record by a variation of at least 1.5 millimetres on the corresponding coordinate.

4. Recording time

(a) Control device must be so constructed that the period of driving time is always recorded automatically and that it is possible, through the operation where necessary of a switch device to record separately the other periods of time as follows:

- (i) under the sign : driving time;
- (ii) under the sign : all other periods of work;
- (iii) under the sign : other periods of availability, namely:
 - waiting time, i.e. the period during which drivers need remain at their posts only for the purpose of answering any calls to start or resume driving or to carry out other work,
 - time spent beside the driver while the vehicle is in motion,
 - time spent on a bunk while the vehicle is in motion;
- (iv) under the sign : breaks in work and daily rest periods.

Each Contracting Party may permit all the periods referred to in subparagraphs (ii) and (iii) above to be recorded under the sign  on the record sheets used on vehicles registered in its territory.

(b) It must be possible, from the characteristics of the traces, their relative positions and if necessary the signs laid down in paragraph 4 (a) to distinguish clearly between the various periods of time.

The various periods of time should be differentiated from one another on the record by differences in the thickness of the relevant traces, or by any other system of at least equal effectiveness from the point of view of legibility and ease of interpretation of the record.

(c) In the case of vehicles with a crew consisting of more than one driver, the recordings provided for in paragraph 4 (a) must be made on two separate sheets, each sheet being allocated to one driver. In this case, the forward movement of the separate sheets must be effected either by a single mechanism or by separate synchronized mechanisms.

D. CLOSING DEVICE

1. The case containing the record sheet or sheets and the control of the mechanism for resetting the clock must be provided with a lock.
2. Each opening of the case containing the record sheet or sheets and the control of the mechanism for resetting the clock must be automatically recorded on the sheet or sheets.

E. MARKINGS

1. The following markings must appear on the instrument face of the control device:
 - Close to the figure shown by the distance recorder, the unit of measurement of distance, indicated by the abbreviation “km”,
 - near the speed scale, the marking “km/h”,

- the measurement range of the speedometer in the form “Vmin ... km/h, Vmax ... km/h”. This marking is not necessary if it is shown on the descriptive plaque of the equipment.

However, these requirements shall not apply to control devices approved before 10 August 1970.

2. The descriptive plaque must be built into the equipment and must show the following markings, which must be visible on the control device when installed:

- name and address of the manufacturer of the equipment,
- manufacturer's number and year of construction,
- approval mark for the control device type,
- the constant of the equipment in the form “k = ... rev/km” or “k = ... imp/km”,
- optionally, the range of speed measurement, in the form indicated in point 1,
- should the sensitivity of the instrument to the angle of inclination be capable of affecting the readings given by the equipment beyond the permitted tolerances, the permissible angle expressed as:

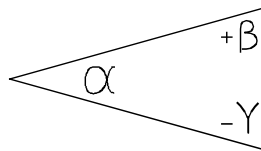

where α is the angle measured from the horizontal position of the front face (fitted the right way up) of the equipment for which the instrument is calibrated, while β and γ represent respectively the maximum permissible upward and downward deviations from the angle of calibration α .

F. MAXIMUM TOLERANCES (VISUAL AND RECORDING INSTRUMENTS)

1. On the test bench before installation:

(a) distance travelled:

1% more or less than the real distance, where the distance is at least 1 kilometre;

(b) speed:

3 km/h more or less than the real speed;

- (c) time:
two minutes per day with a maximum of 10 minutes per 7 days in cases where the running period of the clock after rewinding is not less than that period.
- 2. On installation:
 - (a) distance travelled:
2% more or less than the real distance, where that distance is at least 1 kilometre;
 - (b) speed:
4 km/h more or less than real speed;
 - (c) time:
two minutes per day, or
10 minutes per seven days.
- 3. In use:
 - (a) distance travelled:
4% more or less than the real distance, where that distance is at least 1 kilometre;
 - (b) speed:
6 km/h more or less than the real speed;
 - (c) time:
two minutes per day, or
10 minutes per seven days
- 4. The maximum tolerances set out in paragraphs 1, 2 and 3 are valid for temperatures between 0 and 40 C, temperatures being taken in close proximity to the equipment.
- 5. Measurement of the maximum tolerances set out in paragraphs 2 and 3 shall take place under the conditions laid down in Chapter VI.

IV. RECORD SHEETS

A. GENERAL POINTS

- 1. The record sheets must be such that they do not impede the normal functioning of the instrument and that the records which they contain are indelible and easily legible and identifiable.

The record sheets must retain their dimensions and any records made on them under normal conditions of humidity and temperature.

In addition it must be possible by each crew member to enter on the sheets, without damaging them and without affecting the legibility of the recordings, the following information:

- (a) on beginning to use the sheet - his surname and first name;
- (b) the date and place where use of the sheet begins and the date and place where such use ends;
- (c) the registration number of each vehicle to which he is assigned, both at the start of the first journey recorded on the sheet and then, in the event of a change of vehicle, during use of the sheet;
- (d) the odometer reading:
 - at the start of the first journey recorded on the sheet,
 - at the end of the last journey recorded on the sheet,
 - in the event of a change of vehicle during a working day (reading on the vehicle to which he was assigned and reading on the vehicle to which he is to be assigned);
- (e) the time of any change of vehicle.

Under normal conditions of storage, the recordings must remain clearly legible for at least one year.

2. The minimum recording capacity of the sheets, whatever their form, must be 24 hours.

If several discs are linked together to increase the continuous recording capacity which can be achieved without intervention by staff, the links between the various discs must be made in such a way that there are no breaks in or overlapping of recordings at the point of transfer from one disc to another.

B. RECORDING AREAS AND THEIR GRADUATION

1. The record sheets shall include the following recording areas:
 - an area exclusively reserved for data relating to speed,
 - an area exclusively reserved for data relating to distance travelled,
 - one or more areas for data relating to driving time, to other periods of work and availability to breaks from work and to rest periods for drivers.

2. The area for recording speed must be scaled off in divisions of 20 kilometres per hour or less. The speed corresponding to each marking on the scale must be shown in figures against that marking. The symbol “km/h” must be shown at least once within the area. The last marking on the scale must coincide with the upper limit of the range of measurement.
3. The area for recording distance travelled must be set out in such a way that the number of kilometres travelled may be read without difficulty.
4. The area or areas reserved for recording the periods referred to in point 1 must be so marked that it is possible to distinguish clearly between the various periods of time.

C. INFORMATION TO BE PRINTED ON THE RECORD SHEETS

Each sheet must bear, in printed form, the following information:

- name and address or trade name of the manufacturer,
- approval mark for the model of the sheet,
- approval mark for the type or types of control devices in which the sheet may be used,
- upper limit of the speed measurement range, printed in kilometres per hour.

By way of minimal additional requirements, each sheet must bear, in printed form a timescale graduated in such a way that the time may be read directly at intervals of 15 minutes while each 5-minute interval may be determined without difficulty.

D. FREE SPACE FOR HANDWRITTEN INSERTIONS

A free space must be provided on the sheets such that drivers may as a minimum write in the following details:

- surname and first name of the driver,
- date and place where use of the sheet begins and date and place where such use ends,
- the registration number or numbers of the vehicle or vehicles to which the driver is assigned during the use of the sheet,
- odometer readings from the vehicle or vehicles to which the driver is assigned during the use of the sheet,
- the time at which any change of vehicle takes place.

V. INSTALLATION OF CONTROL DEVICE

A. GENERAL POINTS

1. The control device must be positioned in the vehicle in such a way that the driver has a clear view from his seat of speedometer, distance recorder and clock while at the same time all parts of those instruments, including driving parts, are protected against accidental damage.
2. It must be possible to adapt the constant of the control device to the characteristic coefficient of the vehicle by means of a suitable device, to be known as an adaptor.

Vehicles with two or more rear axle ratios must be fitted with a switch device whereby these various ratios may be automatically brought into line with the ratio for which the control device has been adapted to the vehicle.

3. After the control device has been checked on installation, an installation plaque shall be affixed to the vehicle beside the device or in the device itself and in such a way as to be clearly visible. After every inspection by an approved fitter or workshop requiring a change in the setting of the installation itself, a new plaque must be affixed in place of the previous one.

The plaque must show at least the following details:

- name, address or trade name of the approved fitter or workshop,
- characteristic coefficient of the vehicle, in the form “w = ... rev/km” or “w = ... imp/km”,
- effective circumference of the wheel tyres in the form “l = ... mm”,
- the dates on which the characteristic coefficient of the vehicle was determined and the effective measured circumference of the wheel tyres.

B. SEALING

The following parts must be sealed:

- (a) the installation plaque, unless it is attached in such a way that it cannot be removed without the markings thereon being destroyed;
- (b) the two ends of the link between the control device proper and the vehicle;
- (c) the adaptor itself and the point of its insertion into the circuit;
- (d) the switch mechanism for vehicles with two or more axle ratios;
- (e) the links joining the adaptor and the switch mechanism to the rest of the control device;
- (f) the casings required under Chapter III A 7 (b).

In particular cases, further seals may be required on approval of the control device type and a note of the positioning of these seals must be made on the approval certificate.

Only the seals mentioned in (b), (c) and (e) may be removed in cases of emergency; for each occasion that these seals are broken a written statement giving the reasons for such action must be prepared and made available to the competent authority.

VI. CHECKS AND INSPECTIONS

The Contracting Party shall nominate the bodies which shall carry out the checks and inspections.

1. Certification of new or repaired instruments

Every individual device, whether new or repaired, shall be certified in respect of its correct operation and the accuracy of its readings and recordings, within the limits laid down in Chapter III F 1, by means of sealing in accordance with Chapter V B (f).

For this purpose, the Contracting Party may stipulate an initial verification, consisting of a check on and confirmation of the conformity of a new or repaired device with the type-approved model and/or with the requirements of this annex and its appendices or may delegate the power to certify to the manufacturers or to their authorized agents.

2. Installation

When being fitted to a vehicle, the control device and the whole installation must comply with the provisions relating to maximum tolerances laid down in Chapter III F 2.

The inspection tests shall be carried out by the approved fitter or workshop on his or its responsibility.

3. Periodic inspections

(a) Periodic inspections of the control device fitted to vehicles shall take place at least every two years and may be carried out in conjunction with roadworthiness tests of vehicles.

These inspections shall include the following checks:

- that the control device is working correctly,
- that the control device carries the type-approval mark,
- that the installation plaque is affixed,
- that the seals on the control device on the other parts of the installation are intact,
- the actual circumference of the tyres.

(b) An inspection to ensure compliance with the provision of Chapter III F 3 on the maximum tolerances in use shall be carried out at least once every six years, although each Contracting Party may stipulate a shorter interval for such inspection in respect of vehicles registered in its territory. Such inspections must include replacement of the installation plaque.

4. Measurement of errors

The measurement of errors on installation and during use shall be carried out under the following conditions, which are to be regarded as constituting standard test conditions:

- vehicle unladen, in normal running order,
- tyre pressures in accordance with the manufacturer's instructions,
- tyre wear within the limits allowed by law,
- movement of the vehicle: the vehicle must proceed, driven by its own engine, in a straight line and on a level surface, at a speed of 50 ± 5 km/h; provided that it is of comparable accuracy, the test may also be carried out on an appropriate test bench.

Annex-APPENDIX 1B³¹

Requirements for the construction, testing, installation and inspection of the digital control device used in road transport

Article 1

Preamble

1. As this Appendix is an adaptation of Annex IB of Council Regulation (EEC) No. 3821/85 of 20 December 1985 concerning recording equipment in the field of road transport 1, the content of this Annex is not reproduced in the AETR because of its size and its very technical character. For the complete official text and its subsequent amendments, Contracting Parties shall refer to the *Official Journal* of the European Union.

The content of the present Appendix 1B is therefore limited to an introduction citing the references to the relevant texts of the European Union and of the Official Journals in which they were published and highlighting, by means of cross references, the particular points where that Annex has had to be adapted to the context of the AETR.

2. In order to facilitate consultation of that Annex with the adaptations made to take into account the AETR and to allow an overall view of the text, a consolidated version of this Appendix will be elaborated by the secretariat of the United Nations Economic Commission for Europe. However, this version will not have any legal force. This version, elaborated in the official languages of the UNECE, will be updated as necessary.

Article 2

Introductory provisions to Appendix 1B

1. In accordance with paragraph 1 of article 1 above, Contracting Parties are invited, in order to consult Annex IB, to refer to Commission Regulations No. 1360/2002 of 13 June 2002 and No. 432/2004 of 5 March 2004 (*see footnote below for the dates of their publication in the Official Journal of the European Union), adapting for the seventh and eighth times to technical progress Council Regulation (EEC) No. 3821/85 concerning recording equipment in the field of road transport.

2. For the purposes of Appendix 1B:

2.1 The terms in the left column below shall be replaced by the corresponding terms in the right column:

³¹ Introduced by amendment 5.

* As amended by Council Regulation (EC) No. 2135/98 of 24 September 1998 (OJ L 274 of 9 October 1998) as well as by Commission Regulations (EC) No. 1360/2002 of 13 June 2002 (OJ L 207 of 5 August 2002 (corrigendum OJ L 77 of 13 March 2004)) and No. 432/2004 of 5 March 2004 (OJ L 71 of 10 March 2004).

| Terms used in Annex IB | | Terms used in the AETR |
|---|--------------------|--|
| Member States | Replaced by | Contracting Parties |
| MS | | CP |
| Annex (IB) | | Appendix (1B) |
| Appendix | | Sub-appendix |
| Regulation | | Agreement or AETR |
| Community | | UNECE |
| Recording equipment (English version only) | | Control device (English version only) |

2.2 References made to legal texts in the left column below shall be replaced by those in the right column:

| Legal texts of the European Community | | Legal texts of the United Nations Economic Commission for Europe |
|---|--------------------|--|
| Council Regulation (EEC) No. 3821/85 | Replaced by | AETR |
| Council Directive No. 92/23/EEC | | ECE Regulation 54 |
| Commission Directive No. 95/54/EC adapting to technical progress Council Directive 72/245/EEC | | ECE Regulation 10 |

2.3 A list of texts or provisions for which an ECE equivalent does not exist or for which more information is necessary appears below. These texts or information are only quoted for reference.

2.3.1 The limit for setting the speed limitation device, as defined in I (Definitions), bb) of Annex IB/Appendix 1B conforms to the provisions of Council Directive No. 92/6/EEC of 10 February 1992 (OJ, No. L57, 02/03/1992).

2.3.2 The measurement of distances, as defined in I (Definitions), u) of Annex IB/Appendix 1B conforms to the provisions of Council Directive No. 97/27/EC of 22 July 1997, as last amended (OJ, No. L 233, 25/08/1997).

2.3.3 Vehicle identification, as defined in I (Definitions), nn) of Annex IB/Appendix 1B conforms to the provisions of Council Directive No. 76/114/EEC of 18 December 1975 (OJ, No. L 24, 30/01/1976).

2.3.4 The provisions on security shall conform with the provisions laid out in Council Recommendation No. 95/144/EC of 7 April 1995, on common information technology security evaluation criteria (ITSEC) (OJ, No. L 93, 26/04/1995).

2.3.5 The protection of individuals with regard to the processing of personal data and the free movement of such data conform to the provisions of Council Directive No. 95/46/EC of 24 October 1995, as last amended (OJ, No. L 281, 23/11/1995).

2.4 Other provisions to be changed or deleted:

2.4.1 The content of requirement 172 is deleted and replaced by 'Reserved'.

2.4.2 Requirement 174 is changed as follows:

'the distinguishing sign of the Contracting Party issuing the card. The distinguishing signs of non EU Contracting Parties are those drawn up in accordance with the 1968 Vienna Convention on Road Traffic or the 1949 Geneva Convention on Road Traffic'.

2.4.3 The reference to the EU flag with the letters 'MS' meaning 'Member State' in requirement 178 is replaced by the letters 'CP' meaning 'Contracting Party', the flag of the non EU Contracting Party being optional.

2.4.4 Requirement 181 is changed as follows:

'After consulting the UN/ECE secretariat, Contracting Parties may add colours or markings, such as security features, without prejudice to the other provisions of this Appendix'.

2.4.5 Requirement 278 is changed as follows:

'Interoperability tests are carried out by a single competent body'.

2.4.6 Requirements 291 to 295 are deleted and replaced by 'Reserved'.

2.4.7 In Appendix 9/Sub-appendix 9 of the AETR (Type approval - List of minimum required tests), 1, 1-1, the introductory sentence is modified as follows:

'The type approval procedure for the recording equipment (or component) or tachograph card is based on:'

APPROVAL MARK AND CERTIFICATES

I. APPROVAL MARK

1. The approval mark shall be made up of:

A rectangle, within which shall be placed the letter “e” followed by a distinguishing number for the country which has issued the approval in accordance with the following conventional signs:

| | | | |
|--------------------|----|--|----|
| Germany | 1 | Greece | 23 |
| France | 2 | Ireland | 24 |
| Italy | 3 | Croatia | 25 |
| Netherlands | 4 | Slovenia | 26 |
| Sweden | 5 | Slovakia | 27 |
| Belgium | 6 | Belarus | 28 |
| Hungary | 7 | Estonia | 29 |
| Czech Republic | 8 | Moldova | 30 |
| Spain | 9 | Bosnia-Herzegovina | 31 |
| Serbia | 10 | Latvia | 32 |
| United Kingdom | 11 | Liechtenstein | 33 |
| Austria | 12 | Bulgaria | 34 |
| Luxembourg | 13 | Kazakhstan | 35 |
| Switzerland | 14 | Lithuania | 36 |
| Norway | 16 | Turkey | 37 |
| Finland | 17 | Turkmenistan | 38 |
| Denmark | 18 | Azerbaijan | 39 |
| Romania | 19 | The former Yugoslav Republic of Macedonia | 40 |
| Poland | 20 | Andorra | 41 |
| Portugal | 21 | Uzbekistan | 44 |
| Russian Federation | 22 | Ukraine | 46 |
| | | Cyprus | 49 |
| | | Malta | 50 |

Subsequent numbers shall be assigned:

- (i) To countries Contracting Parties to the 1958 Agreement Concerning the Adoption of Uniform Conditions of Approval and Reciprocal Recognition of Approval for Motor

32 Modified by amendments 2, 3 and 5.

Vehicle Equipment and Parts the same numbers as assigned to those countries by that Agreement;

- (ii) To countries non-Contracting Parties to the 1958 Agreement - in the chronological order in which they ratify or accede to this Agreement;

and

An approval number corresponding to the number of the approval certificate drawn up for the prototype of the control device or the record sheet, placed at any point within the immediate proximity of this rectangle.

Note: In order to ensure in the future conformity between conventional signs in the 1958 Agreement and those set up in the AETR Agreement new Contracting Parties should be allocated the same number in both Agreements.

2. The approval mark shall be shown on the descriptive plaque of each set of control device and on each record sheet. It must be indelible and must always remain clearly legible.

3. The dimensions of the approval mark drawn below are expressed in millimetres, these dimensions being minima. The ratios between the dimensions must be maintained.

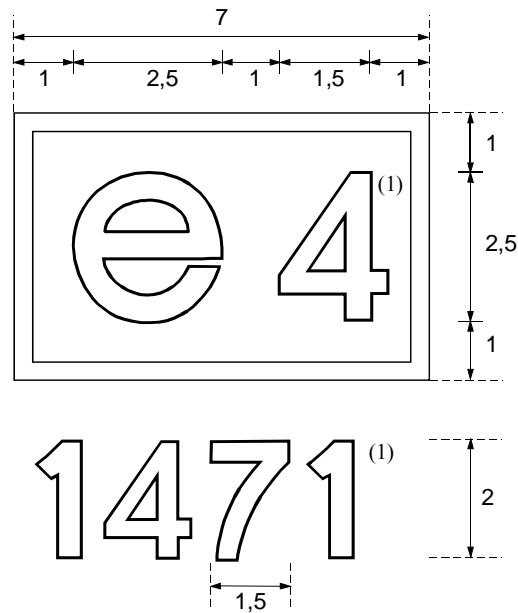

- (1) These figures are shown for guidance only.

II. APPROVAL CERTIFICATE FOR PRODUCTS IN ACCORDANCE WITH APPENDIX 1³³

A Contracting Party having granted approval shall issue the applicant with an approval certificate, the model for which is given below. When informing other Contracting Parties of approvals issued or, if the occasion should arise, withdrawn, a Contracting Party shall use copies of that certificate.

APPROVAL CERTIFICATE

Name of competent administration

Notification concerning:*

- approval of a type of control device
 - withdrawal of approval of a type of control device
 - approval of a model record sheet
 - withdrawal of approval of a record sheet
-

Approval No.

1. Trade mark or name
2. Name of type of model
3. Name of manufacturer
4. Address of manufacturer
5. Submitted for approval on
6. Tested at
7. Date and number of test report
8. Date of approval
9. Date of withdrawal of approval
10. Type or types of control device in which sheet is designed to be used.....
11. Place
12. Date
13. Descriptive documents annexed

14. Remarks

(Signature)

33 Title modified by amendment 5.

* Delete items not applicable

**III. APPROVAL CERTIFICATE FOR PRODUCTS IN ACCORDANCE WITH
APPENDIX 1B ³⁴**

Once the Contracting Party has effected an approval it issues the applicant with an approval certificate, drawn up in accordance with the model below. Contracting Parties use copies of this document in order to communicate to other Contracting Parties approvals granted or any withdrawals.

APPROVAL CERTIFICATE FOR PRODUCTS IN ACCORDANCE WITH APPENDIX 1B

Name of the competent administration

Communication concerning (1):

- Approval
- Withdrawal of an approval
 - Of a control device model
 - Of a control device component (2)
 - Of a driver card
 - Of a workshop card
 - Of a company card
 - Of an inspector's card

-
- Approval No.
1. Manufacturing or commercial mark.....
 2. Name of model.....
 3. Name of manufacturer.....
 4. Address of manufacturer.....
 5. Submitted for approval on.....
 6. Test laboratory or laboratories.....
 7. Date and No. of reports.....
 8. Date of approval.....
 9. Date of withdrawal of approval.....
 10. Model(s) of component(s) of control device with which the component is intended to be used.....
 11. Place.....
 12. Date.....
 13. Descriptive documents annexed.....
 14. Remarks (including the affixing of seals if required)

.....
(Signature)

- (1) *Tick the relevant boxes*
(2) *Specify the component concerned in the communication*
-

³⁴ Introduced by amendment 5.

PROTOCOL OF SIGNATURE

PROTOCOL OF SIGNATURE

When signing the European Agreement concerning the Work of Crews of Vehicles engaged in International Road Transport, the undersigned, duly authorized have agreed on the following:

The Contracting Parties declare that this Agreement is without prejudice to such provisions as may, if appropriate, subsequently be drawn up in the matter of the duration and spread-over of work.

ad article 4 of the Agreement

The provisions of article 4, paragraph 1, shall not be construed as rendering applicable, outside the State in which the vehicle performing the transport operation is registered, any prohibition of traffic on certain days or at certain hours which may apply in that State to certain categories of vehicles. The provisions of article 4, paragraph 2, shall not be construed as preventing a Contracting Party from enforcing in its territory the provisions of its domestic laws and regulations which prohibit certain categories of vehicle traffic on certain days or at certain hours.

Every Contracting Party which, being a Party to a special agreement as referred to in article 4, paragraph 2, of this Agreement, authorizes international transport operations beginning and ending in the territories of the Parties to the said special agreement by vehicles registered in the territory of a State which, being a Contracting Party to this Agreement, is not a Party to the said special agreement may make it a condition for the conclusion of bilateral or multilateral agreements authorizing such transport operations that the crews performing those operations shall, in the territories of States Parties to the said special agreement, comply with the provisions of the said special agreement.

ad article 12 of the Agreement

The undersigned undertake to discuss after the Agreement has entered into force the insertion therein, by means of an amendment, of a clause providing for the use of a control device of approved type which when placed on the vehicle would so far as possible replace the individual control book.

ad article 14 of the Agreement

The Contracting Parties recognize that it would be desirable for:

- each Contracting Party to adopt the measures necessary to enable it to institute proceedings on account of breaches of the provisions of the Agreement not only if the breaches are committed in its territory, but also if they are committed in the territory of another State during an international road transport operation performed by a vehicle which the Contracting Party has registered;
- them to afford one another assistance for the purpose of imposing penalties for breaches committed.

ad annex to the Agreement

Notwithstanding paragraph 4 of the general provisions of the annex to this Agreement, Switzerland may dispense with the requirement that employers must sign the weekly reports in the individual control book.

IN WITNESS WHEREOF, the undersigned, being duly authorized thereto, have signed this Protocol.

DONE at Geneva, this first day of July nineteen hundred and seventy, in a single copy, in the English and French languages, the two texts being equally authentic.

* * *